

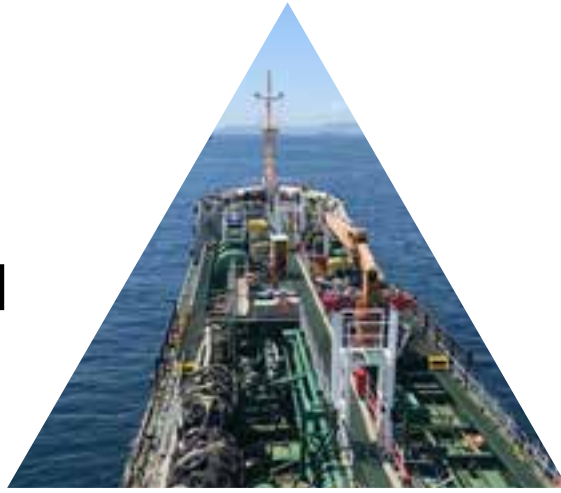

OCEANTECH
SHIPPING & TRADING LTD



SPARE PARTS
CATALOGUE
& **TECHNICAL**
SERVICES



Your trusted **Marine Spare Part Distributor**

About us

Oceantech Shipping & Trading LTD is a Marine orientated Spare Parts Trading & Technical Consultancy Company, founded back in 2013. Our Headquarters are in Limassol Cyprus, where as our branch office is in Athens-Greece. Oceantech Shipping & Trading LTD has established a strong position as Marine Spare Parts Distributor and Official Representative of well recognized Marine Manufacturers. Moreover, our team focuses on satisfying our customers with supreme customer after sale support.

Main Activities

- Supply of High Quality Spare Parts from Korea, China, Northern Europe & Japan
- Official Representative of Marine Equipment Manufacturers & Service Providers
- Stern Tube Seals Stusters Spares & Service
- Deck Equipment
- Technical Ship Management Services
- Anticorrosive Products - Marine Chemicals
- Marine Environmental Services
- Dry Dock Planning - Ship Surveys
- Vessel Condition Assessment

Our Mission & Core Values

- Reliability for every service we offer to our customers
- To satisfy our customers with our prices and quick response
- To expand our client base and market power
- Responsibility towards the international defined standards and quality procedures
- Flexibility for assisting in due time every ship manager
- Transparent Procedures in all our transactional operations



2-STROKE ENGINE SPARE PARTS

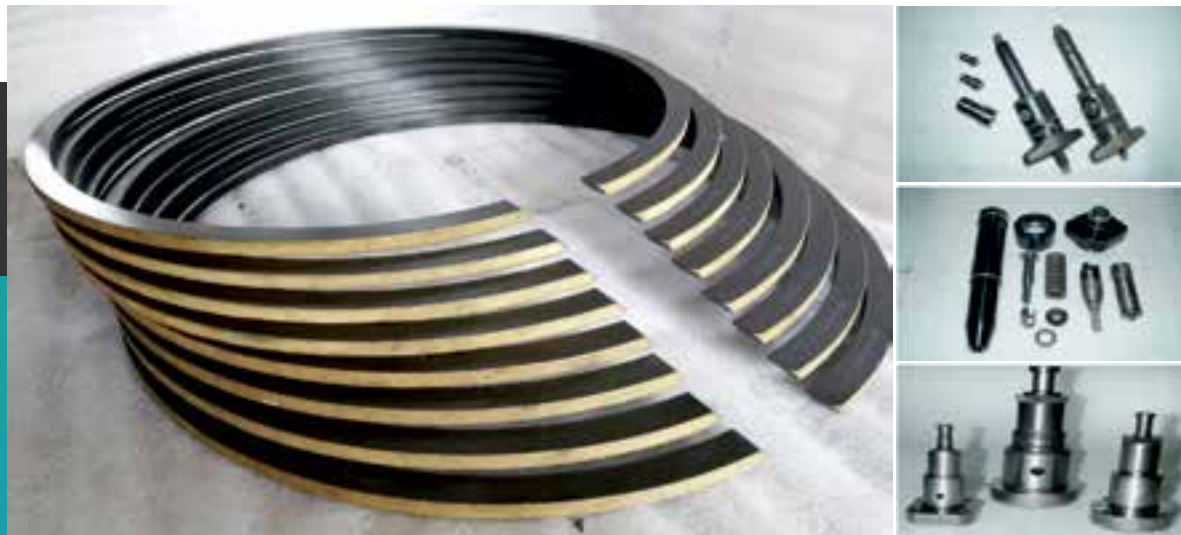

MAKER	KOREA	CHINA	EUROPE
MAN B&W	OEM	OEM	OEM
SULZER	-	OEM	OEM-GENUINE
HSD (ex-DOOSAN) MAN B&W	GENUINE	-	-
HSD WARTSILA	GENUINE	-	-
STX MAN B&W	GENUINE	-	-
MAN B&W HHM (Hudong)	-	GENUINE	-
MAN B&W -YMD - DMD	-	GENUINE	-
MAN B&W (Cegielski Poznan)	-	-	GENUINE
mitsubishi - AKASAKA	OEM	OEM	-

- Bearings
- Fuel Valves
- Piston Skirts
- Liners
- Cylinder Covers
- Cooling Jackets

Engine Manufacturers & Types

MAN B&W: S26MC, L35MC, L42MC, S42MC, S46MC-C, L50MC, L60MC, S60MC-C, S50MC-C, LS60ME-C, S90ME-C, S40ME-B, L80MC, K80MC, K90MC, etc

WARTSILA - SULZER: RTA48T, RTA52, RTA52U, RLA56, RLB56, RTA58, RTA58T, RTA62T, RTA62U, RLA66, RLB66, RTA68, RND68, RTA72, RND 76, RND76M, RTA84, RTA84C, RTA84T, RLA90, RND90, RND90M, etc

AKASAKA-MITSUBISHI: AH27, AH28, AH30, AH33, AH36, DM26, DM28, DM28AR, DM28AFD, UEC45HA, UEC52HA, UEC37LA, UEC45LA, UEC52LA, & VEC, etc

4-STROKE ENGINE SPARE PARTS



Spare Parts for Diesel Generators



MAKER	KOREA	CHINA	EUROPE
MAN B&W	OEM	OEM	OEM
MAN B&W (HHI -HSD - STX)	GENUINE	OEM	-
MAN B&W - SXD	-	GENUINE	-
MAN B&W - Zhenjiang CME	-	GENUINE	-
DAIHATSU	OEM	OEM	-
DAIHATSU ANQING	-	GENUINE	-
DAIHATSU SXD (DK20 & DK28)	-	GENUINE	-
YANMAR	OEM	OEM	-
WARSTILA / SULZER	-	-	OEM - GENUINE
PEGASO GUASCOR	-	-	OEM - GENUINE
CUMMINS & CATERPILLAR	OEM	OEM - GENUINE	GENUINE
MAK	-	-	OEM -GENUINE
DEUTZ -MWM	-	OEM - GENUINE	OEM - GENUINE
ZIBO - WEICHA	-	GENUINE	-

Engine Manufacturers & Types

MAN B&W: L16/24, L20/27, L21/31, L23/30H, L23/30A, L27/38, L28/32, L28/32H, L32/40, etc

DAIHATSU: DK, DL, DS, DC17, DSD, DV, PKTD, PKTB, PL, PS, etc

YANMAR: 6MAL, M220, GL-UT, S185, 6UL, 6ZL, T220, N330, M200, T240, S165, Z280, etc

WARTSILA: L20, V32, L32, L28, L27, AL20-24, AL25-30, ZAV40, etc

Cummins: V504, VT555, VT903, VTA28, Nt855, KT19, LT10, M11, KT2300, KT50, etc

Zibo: N330, LB250, 8300, Z6170, Z2170, etc

MAK: M32, M20, M25, etc

MAKER	KOREA	CHINA	EUROPE	JAPAN
TAIKO - KIKAI	OEM	OEM	-	GENUINE
TEIKOKOU	OEM	OEM	-	GENUINE
NANIWA	OEM	-	-	GENUINE
SHIN SHIN	OEM - GENUINE	OEM	-	-
ISHI	OEM	-	-	-
SHINKO	OEM	-	-	-
MIURA	OEM	-	-	GENUINE OEM
IMO	-	-	OEM	-
LEISTRITZ	-	-	GENUINE	-
HEISHIN	OEM	-	-	-
IRON	OEM	-	OEM - GENUINE	-
DICKOW PUMPEN	-	-	GENUINE	-
ALLWEILER	-	-	OEM - GENUINE	-
DESMI	-	-	GENUINE	-
RICKMEIER	-	-	GENUINE	-
VATEC - MASCHINERY	-	-	GENUINE	-
HAMWORTHY	-	-	OEM	-
AZCUE	-	-	GENUINE	-
TIANJIN & MACHINERY	-	GENUINE	-	-



Mechanical Seals



Impellers for all kind of centrifugal pumps

Pump Manufacturers & Types

IRON: CNLB, CNL, DHBS etc

HAMWORTHY: CGC, CGA, CGB, CGD etc

ALLWEILER: NT, AEB, MI, NB, NS, NIM, MA etc

IMO: ACD, ACE, ACG, LPD, LPQ etc

TAIKO KIKAI: ESC, ESD, EMC, EMD etc

MIURA: MCT, MRP, CPM etc

TEIKOKU: 2 VCS, MSS, CSM, DVM etc

HEISHIN: HCY, CY, HK, HLY, MA, NE, PSY, PV, RV etc

AZCUE: VRX, AN, AN VP/ED, LN, VM, VR etc





Quality Parts from Korea & Europe

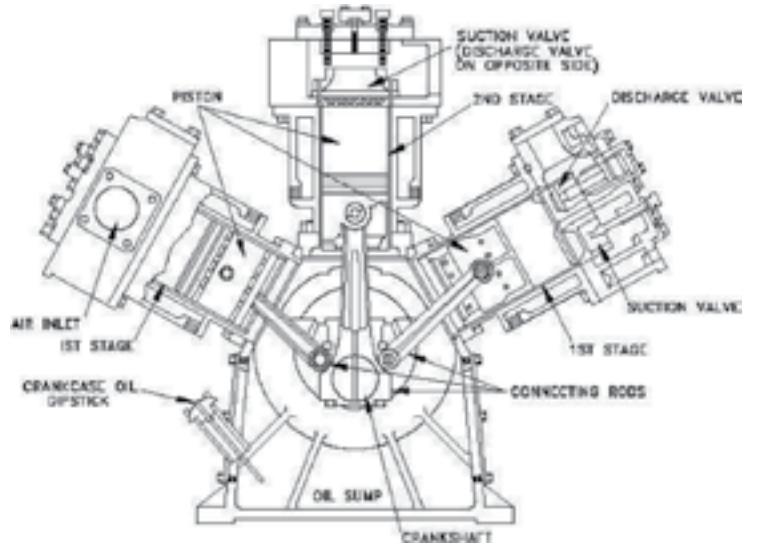

MAKER	KOREA	CHINA	EUROPE	JAPAN
TANABE	OEM	OEM	OEM	GENUINE
YANMAR	OEM	OEM	-	GENUINE
HAMWORTHY	-	-	OEM	-
JP SAUER	-	OEM	OEM - GENUINE	-
MATSUBARA	OEM	-	-	-
SPEREE	-	-	OEM - GENUINE	-
ALUP	-	-	OEM - GENUINE	-
H. CEGIELSKI POZNAN (HCP)	-	-	OEM - GENUINE	-
TAMROTOR	-	-	OEM - GENUINE	-
BECKER	-	-	GENUINE	-

Why OEM?

- High Quality Products at Cost—Effective Prices
- Immediate Availability
- Worldwide Supply
- Customer Support Equal to the one of the Maker

Air Compressor Manufacturers & Types

Tanabe: VLH series, HC 65A, 263, 264A, 265, 275A, SHC series, etc

Yanmar: SC 5N, 7N, 10N, 30N, 40N, 50N, 60N, 75N, etc

Spere: HL2/77, LL2/77, LL2/160, HL2/160, HV2/240, etc

Hamworthy: 2SF3, 2TM68, V150, V200, 2MF64, 2TM63, 2TF54, etc

Tamrotor: TMC, EMH, L series, etc

Becker: VT, VX, KVX, KVT, VXLF, VTFLF series, etc

Alup: SCK42, SCK22, etc

JP Sauer: WP15, WP25, WP40, WP60, WP100, WP200, WP400, etc

PURIFIERS & HEAT EXCHANGERS

MAKER	KOREA	CHINA	JAPAN	EUROPE
ALFA LAVAL	-	OEM	-	OEM
WESTFALIA	-	-	-	OEM - GENUINE
MITSUBISHI	OEM - GENUINE	OEM	OEM	-

Manufacturers & Types:

Purifiers:

Alfa Laval: MAPX, MOPX, MAB series

Westfalia: OSA, OTA, OTB, OSB, OSC, SAOG series

Mitsubishi: SJ, T,G, F series

MAKER	KOREA	CHINA	JAPAN	EUROPE
ALFA LAVAL	-	OEM	-	OEM
AP_SONDEX	-	-	-	OEM-GENUINE
HISAKA	OEM	OEM	-	-
LHE	GENUINE	-	-	-
ATLAS DENMARK	-	-	-	GENUINE

Manufacturers & Types:

Heat Exchangers & F.W. Generators:

Alfa Laval: , JWP-16, JWP-26, DPU36C, M3—M30 series etc

LHE: PE60L, HT151 NBR, HT232 etc

Atlas Denmark: AFGU series



18 months
extended warranty
for all spares



CUMMINS GENERATORS

Service Station—Michelioudakis



Oceantech Shipping & Trading LTD proudly introduces our associate workshop "Cummins Service—Michelioudakis", a long established service station and service provider for Cummins Engine repairs



Main Activities

- Repair & Overhauling of Cummins Engines
- Supply of OEM and Genuine Spare Parts
- Reconditioning and Calibration of PT Fuel Pumps/ Injectors
- Supply on exchange basis and repair of critical spare parts such as Turbochargers, Pumps, Cylinders Covers, Injectors, Governors etc
- Supply of 2nd hand spare parts



Types & Models

- CUMMINS 4BT 3.9lt, 6BT 5.9lt, 6CT 8.3lt
- CUMMINS V504, VT555, VT903, VTA28
- CUMMINS NT 855, KT 19, LT 10, M11
- CUMMINS KT 2300, KT 50



Cummins Service - Michelioudakis with over 40 years of experience, is your one stop Service Station for offering any kind of Technical Support, Gensets Rental Schemes for your needs and Quality Spare Parts. 24/7 Guaranteed Availability



AUXILIARY MACHINERY

MAKER	PRODUCTS
ACE VALVE	BUTTERFLY VALVES
AURAMARINE	FO SUPPLY UNIT
ARIM MACHINERY & ENG. Co	WINCHES, CRANES, DAVITS
CENTURY	PACKAGE AIR CONDITIONER
DAE YANG	ELECTRIC LIGHT, THERMO COUPLE, NAVIGATION SYSTEM, VENT FANS, ELECTRICAL EQUIPMENT
DONGNAM CRANE	PROVISION CRANE
DONG HWA ENTEC.	AIR COOLER, HEAT EXCHANGER, FW GENERATOR
GEORIM ENGINEERING Co Ltd	OILY WATER SEPARATOR
DONG HWA PNEUTEC (EX. JONGHAP PNEUTEC)	AIR COMPRESSOR
HANLA LEVEL	LEVEL GAUGES
HANSIN ELECTRONICS	TELEPHONE SYSTEM
HANYOUNG ENGINEERING	OILY WATER SEPARATOR
HI-AIR KOREA	AIR CONDITIONER, PROVISION REFREGIRATOR
HYUNDAI MARINE MACHINERY Co Ltd	AUX. BLOWER, FAN, INCINERATOR
IL SUNG Co Ltd	SEWAGE TREATMENT
JUNG—A	MARINE WINDOW WIPERS
KANGRIM INDUSTRIES	BOILER, INCINERATOR, IGS
KC CO LTD	MGPS, ICCP
KEYSTONE VALVE	BUTTERFLY VALVES
KT ELECTRIC	SWITCH BOARD & CONTROL CONSOLE
NK Co LTD	FIRE FGHTING EQUIPMENT
ORIENTAL PRECISION Co LTD	PROVISION CRANE
SAMGONG Co LTD	PURIFIER
SAMJOO ENG CO LTD	GALLEY EQUIPMENT
SAMKUN CENTURY Co LTD	STERILIZER, CALORIFIER
SARACOM CO LTD	WHISTLE, FIRE DETECTION SYSTEM
YOOWON INDUSTRIES	FILTER STEERING GEAR
AQUAMETRO (DAEHO ELECTRIC.)	FLOWMETER
BERG ARMATUREN	VALVE ACTUATOR
BESI MARINE SERVICES GmbH	VALVES, ACTUATORS
COLTRACO ULTRASONICS	ULTRASONIC SYSTEMS
EEGHOLM	ELECTRICAL MOTORS & COMPONENTS
FLEBU	EXHAUST GAS FANS, INERT GAS FANS
WYNN WIPERS	MARINE WINDOW WIPERS
DEIF	BRIDGE INSTRUMENTS
KIDDE GRAVINER	OIL MIST DETECTOR
NORDIC FLOW CONTROL	VALVE REMOTE CONTROL SYSTEM
PLEIGER MASCHINENBAU GMBH & CO	HYDRAULIC SYSTEMS
STARTWELL ENGINEERING	AIR STARTERS
UTSUKI KEIKO CO.,LTD	BALLAST REMOTE CONTROL SYSTEMS
WAKEFIELD JAPAN CO. LTD	VALVE SPINDLE, VALVE SEATS, EXHAUST VALVE SPINDLE
FLUTECH (TONG MYUNG)	STEERING GEAR
PHE	PLATE HEAT EXCHANGER



Marine propulsion service company

Your partner for Stern tube seals & Marine propulsion parts & services

We keep your Interests First!

Stern Tube Seal Spare Parts

Our Ocean Seal[®] stern tube seal spare parts are made in Europe to our own high specifications, using FKM (commonly referred to as Viton[®]) or HNBR (commonly referred to as Perbunan S[®]). They fit lip seal systems of all major brands of oil-lubricated systems, including air seals. Our Ocean Seal[®] stern tube seal spare parts are compatible with all common maker systems. The materials we use for our stern seals are suitable for both EAL oils and mineral oil.

Complete Stern Tube Seal Service Kits

Our seals are offered with a complete installation kit. Installation kits contain:

Liner O-rings, O-rings for oil lines, Gaskets, Anodes and fasteners. This kit complies with or exceeds your needs. A cost-efficient solution.

Compatible with:

- Simplex (SKF)[®],
- Kobelco[®],
- Kemel[®],
- Eagle Seals[®],
- Wärtsilä[®],
- Lips[®],
- John Crane[®],
- Waukesha[®],
- Chuetsu[®],
- Dover Japan[®],
- JMT (Japan Marine Technology)[®],
- Deep Sea Seals[®],
- IHC Lagersmit[®].

Stern Tube Seal Service

Whether your vessel is in drydock or afloat, whether the shaft is withdrawn or seal bonding is required, you can benefit from our years of experience.

As an independent service provider for the repair and maintenance of propulsion systems, you can expect us to be:

- Ready to travel worldwide.
- Local service stations in the Netherlands, Estonia, China and Turkey.
- Cost efficient.
- Available 24/7.
- Highly motivated, Fast.
- Transparent.
- Realistic.

Technical advice

+ Trouble shooting

RM Propulsion can provide technical advice in case of problems with the stern tube seals. We help customers out 24/7. Free of Charge! If you have any leakages. Please call! Our aim is to keep your vessel going.

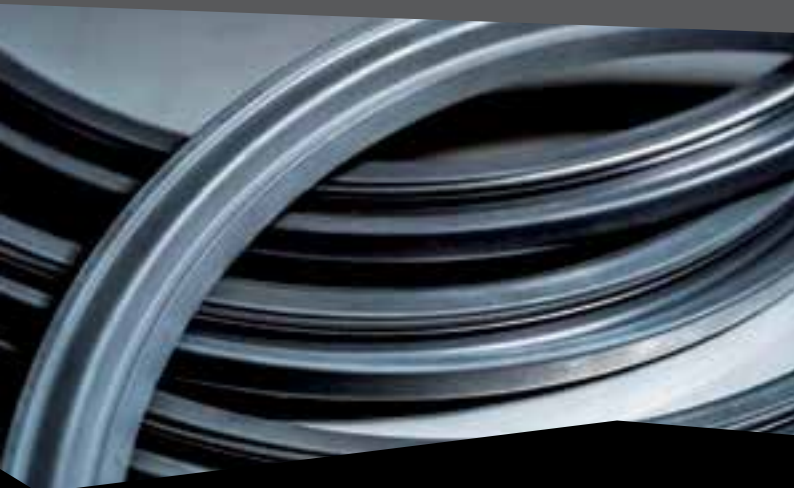

PROPULSION BV
STERN TUBE SEALS
STERN TUBE SEAL SPARES & SERVICES



PROPULSION BV
THRUSTERS
THRUSTER SPARE PARTS & SERVICES



Propulsion Service

We can service Bow-, Stern- and Azimuth thruster, CPP, FP-shaft line and Steering gear.

Our services include:

- Complete general overhaul 5/10 years,
- Pre-docking inspections,
- Check of Maintenance & Operating history,
- Advise about necessary spare parts,
- Warranty on our services.
- Blade foot O-rings replacement
- Shaft seals replacement
- Top seals replacement
- Pinion shaft removal
- Bearings replacement
- Inspection/overhaul of the OD box
- Quick scan of the gear set
- Rolls-Royce®,
- Kamewa®,
- Wärtsilä®/ Lips®,
- Nakashima®,
- Kawasaki®,
- Brunvoll®,
- Suzuki®,
- Aquamaster®,
- Ulstein®,
- Jastram®,
- Schottel®,
- And many more...

Propulsion Spare Parts

We offer a range of propulsion thruster spare parts as part of our overall propulsion services, compatible with most bow, stern, and azimuth thruster systems. These may be included in your quotation unless you have your own spares to use already. We always begin with a free consultation, offering you advice to make sure you can make an educated decision on what you need.

Our thruster spare parts

RM Propulsion offers thruster spare parts for bow, stern, and azimuth applications, as well as CPP and FPP systems. Thruster spare parts compatible with your system; Brand and type-specific kits with everything you need for a full overhaul, including:

- OEM Bearings
- Shaft seals
- Gaskets
- Shims
- O-Rings

Thruster spare part compatibility

We carry propulsion spare parts for systems from a wide range of manufacturers:

- Berg®
- Brunvoll®
- Jastram®
- Kamewa®
- Kamome®
- Kawasaki®
- Kongsberg®
- Lips®
- Nakashima®
- Rolls-Royce®
- Schottel®
- Ulstein®
- Wärtsilä®



All our services come with a detailed service report.



Short lead time, fast delivery!

'creativity at work'

Research & Development

Our RM Propulsion team is creative. We're not satisfied with following in others' footsteps – we want to challenge the unknown ourselves. We see research and development as a key part of our strategy, and we're constantly working to innovate in both our products and our services. This makes us the best we can be – and enables us to be your ideal partner in stern tube and propulsion services.

**In need for Stern tube seals spares,
Thruster spares or overhaul services?**

+31(0)85 070 6610

info@rmpropulsion.com

www.rmpropulsion.com

WORKS WE PERFORM:

- Repairs and Adjust of fuel systems
- Machining and polishing the Crankshaft
- Replacing the Crankshaft
- Grinding the Valves and Valve Seats
- Honing the Cylinder Liners
- Major and Top End Overhauls
- Wear verification of crankshafts and bearings
- Sanding crankshaft journals to any required sub-dimension
- Repair report (measurements)

MAN B&W 4-STROKE SERIES

extensive Stock of individual items suitable for L28/32H, L23/30H, L27/38, V28/32S, L21/31, L16/24, L32/40 including:

- Fuel Equipment
- Bearings
- Piston Rings
- Sealings
- O-Rings etc.

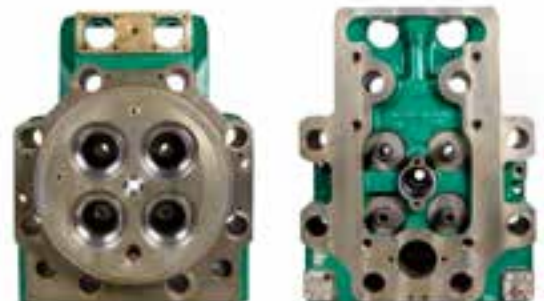

Major equipment stock with Class Certifications:

- Engine blocks, Crankshafts, Pistons (with hardened and chromium plated grooves), Connecting rods, Coolers

2 and 4 STROKE SULZER DIESEL ENGINES

We offer Spare Parts for Diesel Engines including:
Z40, S20, AL20 H, ZA40, S20H, ZA40S, S20U, RT62, RT62U, RT72 U, RT76, RT58, AL20 D, ATL25, ASL25, AL25/30





We are proud to introduce our new partner, **CC Jensen**. They are an innovative provider in glass supply. **CC Jensen** specializes in repairing/upgrading glass and frame constructions on ships. They design, produce, and install ship windows and frame constructions in accordance with all major international and national standards, as well as with **ISO 1751 and ISO 3909**. They are able to offer our highly trained team of engineers, supervisors, technicians, and production staff to achieve the optimal solution.



- Scuttles
- Fixed windows
- Sliding windows
- Fire rated windows & scuttles
- Glass
- Clamp-on windows
- Casted products



Inexa TNF offers unique products, innovative solutions, and fast delivery to every customer. With decades of experience in the industry, the company is distinguished for the quality and reliability of its products.

Whether it's for constructing a cabin or other applications, Inexa TNF provides comprehensive solutions that meet the needs and requirements of each project.



Walls and ceilings built to Norsok standards not only guarantee durability and reliability but also ensure effectiveness in noise cancellation. With **Inexa TNF**, you can be assured that you are choosing one of the top solutions in the field.

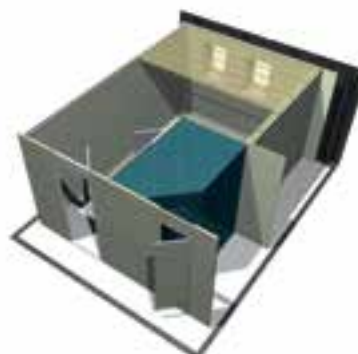

Oceantech Shipping & Trading Ltd is the Official Distributor for the Greek & Cypriot Market of **Sealantern Electronics Co., Ltd.**

Sealantern Electronics Co., Ltd. is a Hi-tech enterprise that mainly produces marine electronic products. Directed by high level technology, Sealantern integrates the R&D and manufacturing, follows the IMO's new regulation and aims the international market to enlarge its productive range and development

Product Categories:

- **MGPS. Marine Growth Preventing System**
- **ICCP. Impressed Current Cathodic Protection System**
- **WIAS. Water Ingress Alarm System**
- (1) **ECR. Integrated Monitoring & Alarm System**
- (2) **Level Gauging & Valve Remote Controlling System**
- (3) **Tanker Monitoring (Level Gauging, temperature, Pressure etc) & Controlling System**
- (4) **Flood Detection System on Passenger Ships**
- (5) **Overflow Monitoring & Alarm System**
- (6) **Anti-Heeling Controlling System**
- **BNWAS. Bridge Navigational Watch Alarm System**
- **VDR/SVDR. Voyage Data Recorder**
- **TOCS Tele - monitoring Oil Consumption System on Shore**
- **WDMAS. Wind & Depth Monitoring Alarm Device**
- **SENSOR. Marine temperature & Pressure Instruments**

Oceantech Shipping & Trading Ltd. can assist your technical department by presenting Sealantern product portfolio, provide 24/7 after sales support, monitor the installation and offer you every kind of spare parts.



Budget effectively the Drydocking Spares of your fleet by using original spare parts from Sealantern Electronics Co.Ltd



Oceantech Shipping & Trading Ltd is proudly introduces our principals **TRELLEBORG**, the Experts on Anti-vibration Solutions and Exhaust Gas Bellows.



We offer:

- Antivibration Mountings
- Components for Flexible Suspension of Exhaust Lines
- Expansion Joints Balance Series
- Exhaust Gas Bellows
- Rubber Expansion Joints



VIBRATION MOUNTS. EVOLVO® SERIES
EVOLVO ADV. GRADE 4.0



Rubber & Steel Expansion Joints



Expansion Joint



Cushyfoot® Mountings



Shock Mountings



Anti-Vibrations Mountings



Bellows-Exhaust Gas

Oceantech Shipping & Trading Ltd is the Official Distributor for the Greek & Cypriot Market of Shanghai **Rongde** Engineering & Equipment Co. Ltd, a company which integrates scientific research and production engineering.

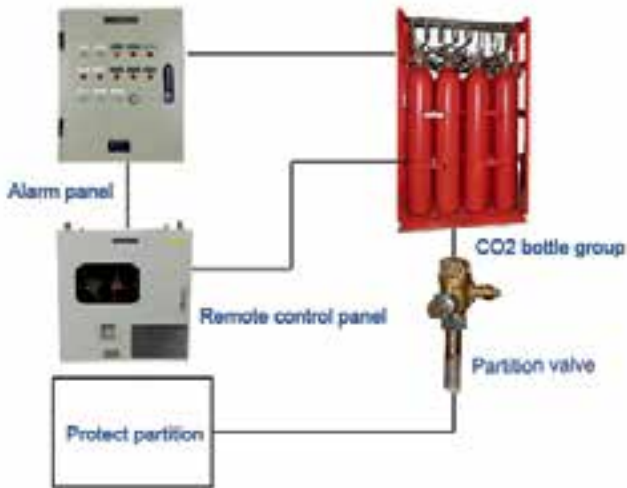

Fixed Waterbased & CO2 Fire Fighting Systems

Product Categories:

- Valve Remote Control and Level Measurement
- Liquid level monitoring and alarm device
- Fire Protection System
- Energy Saving Equipment

Oceantech is the authorized service station in Greece & Cyprus for supplying service for RONGDE Fire Fighting Solutions & Equipment

Float Level Sensors
The float type liquid level measuring device can be used not only for ballast water tanks, fuel oil tanks, draft meters, but also for measuring the liquid level of the cargo tanks, displaying temperature and steam pressure and also issuing an alarm signal when the value exceeds the set limit.



Magnetostrictive liquid level sensor



Double acting hydraulic actuator Electric valve Pneumatic actuators

Oceantech Shipping & Trading Ltd is the Exclusive Distributor of Ferryl Anticorrosive Products for the Hellenic Market. **Ferryl Sales Ltd.** is originally a Swedish company, founded in 1955. Currently, they are manufacturers of special anticorrosive greases, oils and coatings, designed for ships.

Products:

- Wire Rope Lubricator
- 202 Standard Anticorrosive Grease
- 101 Anticorrosive Oil
- 103 Anticorrosive Drying Oil
- Rustoil Penetrating Oil
- 400R Anticorrosive White Coating
- 401 Anticorrosive Transparent Coating
- Ferrycid Rust remover
- Cleaning Fluid Oil & Grease Remover
- Electroclean
- Armacit Pipe Sealant

Advantages:

- Ultimate Rust Protection & Lubrication
- Extend of Wire Life & Efficiency
- Superior Penetration
- Easy to Apply
- Designed for the Harsh Marine Environment
- Non-Toxic & Biodegradable



Ferryl Global Stock Points

- Piraeus - Greece
- Houston - USA
- Singapore
- Rotterdam - Holland
- Hamburg - Germany
- Antwerp - Belgium
- Shanghai - China
- Busan - South Korea
- Dubai - UAE
- Kobe - Japan
- Algeciras - Spain
- Gdansk - Poland
- Valleta - Malta
- Limassol - Cyprus
- Manzanillo - Mexico

VGP Compliance

Ferryl Sales Ltd. declares that the wire-rope lubrication products comply with the requirements set by the United States Environmental Agency's (EPA) 2013 for the Vessel General Permit and can therefore be considered as Environmental Acceptable Lubricants.

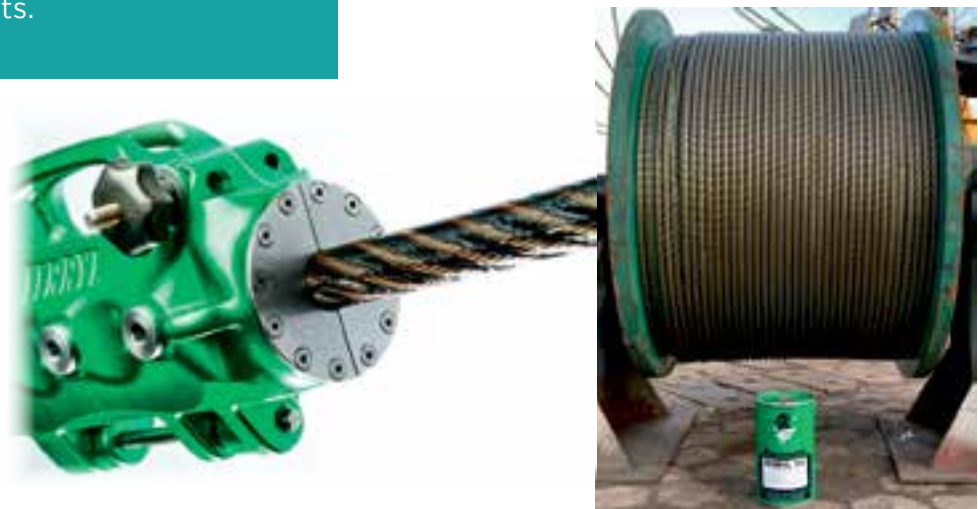



Since 2007, comprehensive fire safety systems and equipment have been provided in maritime markets. Through continuous improvements, the provision of both tailored and specialized solutions to clients worldwide has been achieved. Their products undergo thorough and independent testing, ensuring full compliance with current safety regulations and standards.

Products:

- Deck Foam fighting System
- Fire detection
- CO2 fire fighting
- Low pressure water mist
- Dry Powder Chemical Fire Fighting
- Low pressure CO2 system
- Water Spray
- Fixed Water Monitor System
- Fire fighting and life saving
- Cooling Nozzles(Class Approval)
- N2 cylinders system



Wolong Lifeboats represents a guarantee in the field of lifeboat safety. With impressive facilities, decades of experience, and over 80 highly skilled personnel, it stands as the top choice in constructing all types of lifeboats that naturally meet the requirements of SOLAS 1944, LSA, and MSC (81.70).



Through their exceptional craftsmanship, state-of-the-art equipment, and a comprehensive quality system, they manage to produce over 150 different sets of lifeboats.



Products:

- Totally enclosed lifeboat
- Free fall lifeboat
- FRP rescue boat
- Fast rescue boat
- Partially enclosed lifeboat
- Open frp lifeboat



13 Vakchou Str., 16672, Vari, Greece
Tel: +30 2130337678 | Fax: +30 2130337680
Email: oceantech@ost.gr www.ost.gr