

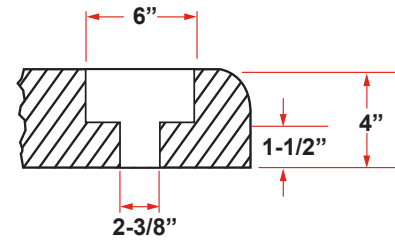

DOCK FITTINGS

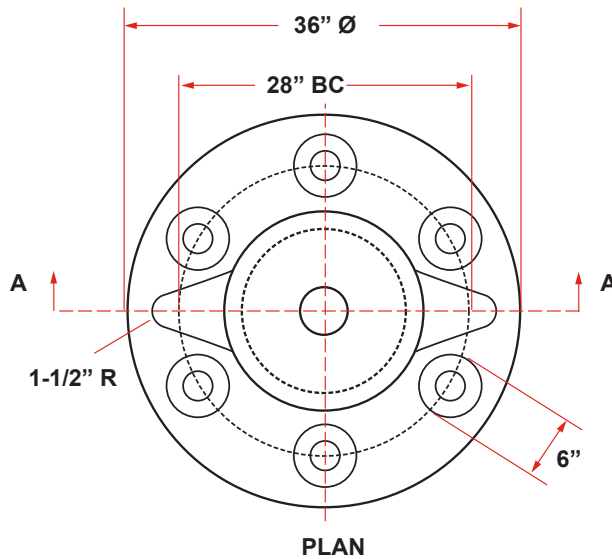
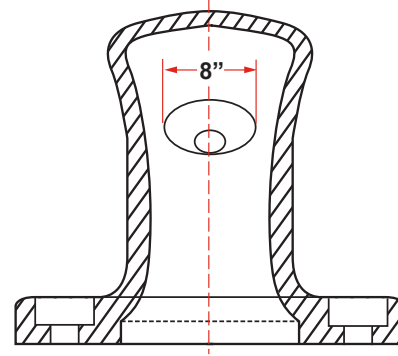
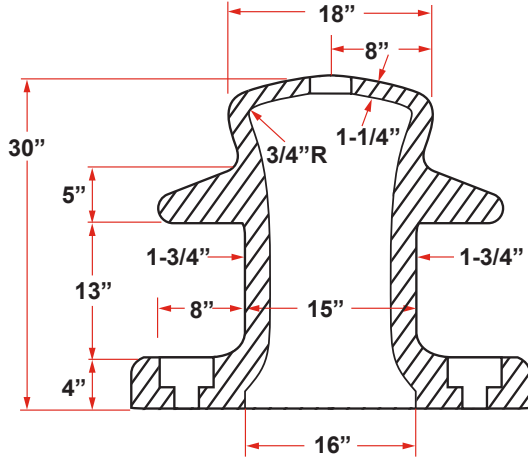

2-3/8" Ø CORE FOR
2-1/4" Ø BOLT

100 TON BOLLARD AMB-100



P. O. Box 596 (90748) • 910 Mahar Ave., Wilmington, CA 90744
 (800) 322-3131 • (310) 522-9698 • Fax: (310) 522-1043
 E-Mail: sales@watermansupply.com
www.watermansupply.com
 TradeNet ID 61935